

# Escudo panel fan



### Main features:





- ABS plastic
- ball bearings
- IPX4
- maximum operating temperature 40°C
- ceiling installation allowed
- 5 years warranty
- non-return valve (ZZ) usage ability

  
30 000  
h





**5**  
5 YEARS  
WARRANTY

Ø100		Ø125		Ø150	
37 dB	95 m³/h	42 dB	175 m³/h	46 dB	205 m³/h
13 W	38 Pa	18 W	50 Pa	18 W	45 Pa

## Equipment

	Easy Clip	▼
	Terminal block	▼
	Pull switch	▼
	Timer (switch off delay)	▼
	Humidity sensor + timer	▼



	INDEX				
ø100	WE*100	●			
	WE*100W		●		
	WE*100T			●	
	WE*100H			●	●
ø125	WE*125	●			
	WE*125W		●		
	WE*125T			●	
	WE*125H			●	●
ø150	WE*150	●			
	WE*150W		●		
	WE*150T			●	
	WE*150H			●	●

## Dimensions

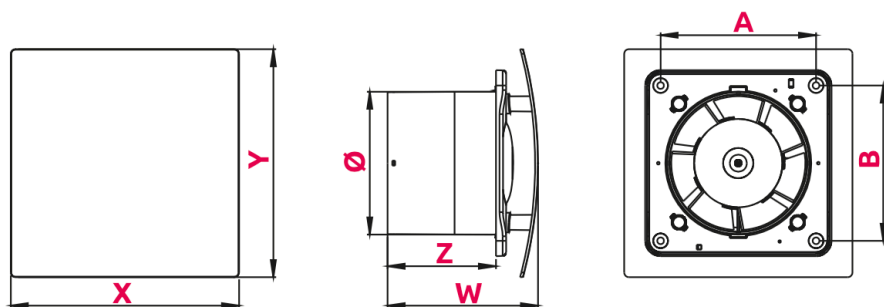

	Ø	A	B	X	Y	W	Z
ø100	100	109	109	160	160	105	77
ø125	125	137	137	188	208	113	77
ø150	150	162	162	188	208	119	83