

# OPERATING MANUAL AIR EXHAUST FAN

## WXO · WXS · WXA

### IMPORTANT NOTICE

Please read the Operating Manual carefully before attempting to install or service the air exhaust fan! **AWENTA shall not be liable for any damage resulting from incorrect operation, non-intended use or unauthorized repair or modifications of the product.**

The Operating Manual and the installation instructions contained in it are an essential part of the product equipment. The Operating Manual specifies important technical information and instructions for the operating safety of the fan. Carefully read the installation instructions in the Operating Manual. Keep the Operating Manual available for future reference. A copy of the Operating Manual can be downloaded from [www.awenta.pl](http://www.awenta.pl)

### Warnings

The following safety symbols show important safety information. Follow all safety regulations and the safety symbols shown in the Operating Manual to avoid injury and hazards.



Danger!



Electrocution hazard: high voltage!



Attention rotating elements!

### Safety precautions:

- This product can be used by children at least 8 years old, by people with impaired physical

and/or mental abilities, and by people without any experience in or understanding of the operation of the product, if supervised or instructed by a competent adult in the safe use of the product so that they understand the relevant operating risks. This product is not a toy and children should not play with it. Children should not be allowed to clean or maintain the product without supervision of an adult.

- The fan is intended for permanent installation and connection with the building electrical system. The building electrical system connected to the fan must be capable of breaking live voltage contact on all switching poles to fully isolate the fan from power during Category III overvoltage conditions, in accordance to applicable electrical engineering regulations.
- The ventilator is designed for installation at a substantial height, i.e. 2.3 m above the floor. The fan shall only be installed in a position and an orientation specified in the Operating Manual, given the necessary entry of the power cable into the fan housing.
- Before servicing the fan, isolate it from the mains voltage with the circuit breaker. Secure the circuit breaker against inadvertent operation.
- The fan installation design must prevent reverse flow of flue gas into the room from open flue gas exhaust ducts and appliances operated with open flames.

- Never attempt to modify or alter the fan without authorization.
- Before installing the fan, verify the load bearing capacity of the installation substructure. Improper installation fastening may result in damage or failure of the fan and hazards to the people nearby.



The fan can be hazardous when operated against its intended use or installed by unqualified personnel.

### Application and operating conditions

- The air exhaust fan is intended for handling air of normal quality or with a low dust content (with a particle size  $< 10 \mu\text{m}$ ) and of low aggressiveness and humidity. The air exhaust fan is intended for operation in temperate climate conditions and within the performance limits specified in the product catalogue.
- The air exhaust fan may be operated only in a permanent indoor installation and with its power supply line concealed.
- The maximum temperature of the medium handled by the air exhaust fan and the maximum ambient temperature are  $+40^{\circ}\text{C}$ .
- The air exhaust fan is an IPX4 and protection class II device. The fan can be installed in indoor moisture Zone 2, in accordance with PN-IEC 60364-7-701, provided that the following requirements from the air exhaust fan manufacturer are complied with:
  - 1 - the correct installation in a ceiling or wall position is maintained with a proper seal of the power supply line in the grommet (see Section "Installation")
  - 2 - the air exhaust duct is secured by a cover from direct exposure to water per IPX4 and direct access to live and/or rotating parts, including the fan rotor in motion; or the air exhaust duct is at least 800 mm long and installed with special tools which will be required to access the air exhaust fan for servicing.
- The air exhaust fan must be operated according to its intended use and within the performance limits specified on the nameplate.
- **Connect the air exhaust fan to the building mains (electrical system) with the following power cable: NYM-O 2x1.5 mm<sup>2</sup> (H07V-K 2x1.5 mm<sup>2</sup>) or NYM-O 3x1.5 mm<sup>2</sup> (H07V-K 3x1.5 mm<sup>2</sup>), maximum outer diameter 7.5 mm, depending on the optional accessories provided.**
- Do not use the fan to handle the air with the following content:
  - viscous contaminants prone to deposition in the air exhaust fan,
  - corrosive contaminants which may degrade the air exhaust fan,
  - flammable contaminants, including gas, vapours, mists or particulates which may form explosive mixtures with air.

- The devices equipped with ball bearings are designed for a minimum operating life of 30,000 hours in S1 duty cycle at the maximum power output and the maximum ambient temperature.
- The control system must prevent extremely frequent power cycling.

### **Transport and storage**

- Keep the fans in their original packaging in a dry, sheltered room.
- The transport and storage ambient temperature limits are -20 °C to +40 °C.
- Protect against impact and shocks. Transport the fan in its original packaging
- If the storage time exceeds 1 year, the motor bearings of the fan must be tested by turning the fan rotor by hand before installation. The fan rotor must run smoothly.
- Dispose of the fan at the end of its operating life strictly in accordance with environmental protection and waste management laws.
- Should it occur, damage caused by improper transport, handling, storage or commissioning will be demonstrated and is not on warranty.

### **ACCESSORIES**

#### **Available optional accessories:**

**Terminal block (standard version, no part index suffix).** *Connect the air exhaust fan with the terminal block as shown in the electrical wiring diagram, see Fig. 2.*

The air exhaust fan is started and stopped by a separate on/off switch installed in the power supply line of the building (and not included with the product).

**Stop delay timer (part index suffix 'T').** *Connect the air exhaust fan with the stop delay timer (a stop delay switch) as shown in the electrical wiring diagram, see Fig. 3.*

The stop delay time can be set with a potentiometer knob on the electronic module of the stop delay timer. The minimum stop delay time is set at 3 min. with the potentiometer knob rotated counter-clockwise to stop. Turn the potentiometer knob clockwise to set a longer stop delay time accordingly. The maximum stop delay time setting is 30 min. The stop delay time is adjusted in infinite increments. The stop delay time is counted down from the time the air exhaust fan senses the indoor lights are off or turning the separate on/off switch off to which the air exhaust fan is connected.

**Hygrostat (part name suffix 'H').** *Connect the air exhaust fan with the air humidity sensor (hygrostat) and timer as shown in the electrical wiring diagram in Fig.3 or Fig.4.*

The air humidity sensor operating range is 40% to 90% of relative humidity. This accessory option includes the stop delay timer. The operation of the air exhaust fan

with these optional accessories will depend on the power supply connection method. If connected as shown in Fig.4, the air exhaust fan will start automatically when the air humidity level exceeds the start threshold of the humidity sensor. Next, the air exhaust fan will stop when the air humidity level is reduced below the stop threshold, plus the stop delay time set with the stop delay timer.

If connected as shown in Fig.3, the air exhaust fan can also be started with its standard light sensor or operating the separate on/off switch. When the indoor light is off or the on/off switch is turned off, the air exhaust fan will stop after the stop delay time set with the potentiometer if the humidity level in the room is below the level preset on the potentiometer. The humidity detection system is the master system.

**NOTE: When the green diode located in the electronic system is on, it means that the humidity level in the room is higher than the preset on the potentiometer controlling the humidity level adjustment. As long as the diode is on, the fan will not start counting down the stop delay after which the fan is switched off. It will take place only after the humidity level in the room drops and the green diode goes off.**

**PIR (part index suffix "R").** *Connect the air exhaust fan with the PIR motion sensor as shown in the electrical wiring diagram, see Fig. 4.*

The air exhaust fan starts when the PIR motion sensor detects someone in the room. The air exhaust fan is equipped with stop delay which is counted from the moment of the last detection of motion in the room. The stop delay time and the sensitivity of the sensor can be set with a potentiometer knob on the electronic module. The adjustment range of the delay is 3 -30 min. Minimum delay time value and the sensor sensitivity is achieved by turning the potentiometer knob counter-clockwise. The stop delay time is adjusted in infinite increments. The maximum sensing range of the PIR motion sensor is shown in the figure 6.

**Fig. (part index ending in "F").** *Fan models with a light sensor and timer should be connected as shown in Fig.4.*

The fan can operate in two modes (use a microswitch located on the controller to change the operating mode):

**Mode A:** The fan is switched on when an increase in light intensity is detected in the room. After the light in the room is switched off, the fan is still working using the switch-off delay setting.

**Mode B:** The fan is switched on when the room lighting is switched off. The fan operates for a preset switch-off delay time or until the lighting system is switched on again.

The fan off delay time can be adjusted by means of a potentiometer located on the controller, in the range of 3–30 minutes. The minimum stop delay time can be set with the potentiometer rotated counter-clockwise.

**Calibration:** After installing the fan, it needs to be calibrated. Calibration is done by switching on and off the room lighting 4 times at intervals of no more than 2 seconds. The end of the calibration process will be signalled by the fan with 8 quick starts.

Calibration can be performed only for the first 5 minutes after the power is turned on. There is no need to recalibrate in case of a power outage.

**NOTE: Fans with a light intensity sensor are designed for completely dark rooms (without windows).**

## INSTALLATION



The fan shall only be installed, connected to electrical mains and commissioned for use by qualified personnel in accordance with applicable laws!

### Assembly

- Precisely determine where the fan will be installed.
- Prepare the power cord. **Use NYM-O 2x1.5 mm<sup>2</sup> (H07V-K 2x1.5mm<sup>2</sup>) or NYM-O 3x1.5 mm<sup>2</sup> (H07V-K 3x1.5mm<sup>2</sup>) with a maximum outside diameter of 7.5 mm, depending on the version of the equipment.**

**NOTE: Before starting work, make sure that the power cord is not live.**

- Measure and drill holes for the fan and  $\varnothing 6$  mm wall plugs included with the product.
- Remove the front clip-on panel (1).
- Remove the fan frame (2) secured by screws (7).
- Remove the housing panel (3), which is fixed with screws (8).
- Run the power cord in double insulation through the grommet (10). Insert a sufficient length of the cord so that the wires can be connected to the power terminals.

**Before mounting the fan: remove all foreign objects from its inside ; check manually that the fan rotor turns freely; make sure there is enough clearance for the outlet check damper to open (sold separately).**

**It is recommended to connect the fan to the duct using a flexible pipe connection!**

- Place the fan housing (6) and the wall plugs in the drilled holes.
- Fasten the fan to the holes in the substructure by driving the screws into wall plugs through the mount holes (9).
- Remove the outer insulation layer from the power cord and remove 4 mm insulation lengths from the wires.
- Run the power cord and connect it according to the wiring diagram applicable to this particular model.

- Verify the tightness of the wires in the terminals.
- Check if the fan is firmly installed and correctly wired.
- Adjust the operating parameters as follows:

**T, H, R and F versions:** Set the delay time and the sensitivity of the motion / humidity sensor with the key (5) and the potentiometer knobs on the electronic module (4).

- Attach the housing panel (3) to the central part of the fan housing (6) with the screw (8).
- Attach the fan frame (2), fasten with screws (7).
- Check the tightness of the power cord.
  - The power cord must be protected so that water cannot penetrate along the cord to interfere with the live parts.
- Install the front panel (1), which serves as a guard against touching the moving parts.



**ATTENTION! A rotating impeller can crush your fingers!**

**It is forbidden to start the fan without a protective mesh against touching the moving parts!**

### First start

Start the air exhaust fan only with all safety precautions in place and all hazards eliminated. Check that it runs steadily and the air is handled efficiently (out of the room and through the air exhaust ductwork to the outside).

Check the operation of the fan (noise, vibration, the possibility to control the rotation speed).

Operate the air exhaust fan only with the front bezel installed, as it is a direct touch guard on the suction side. Depending on the actual installation conditions, the fan may require a protection against touching the moving parts on the delivery side. Suitable delivery-side direct guards can be provided on request. If the fan is guarded against direct touch due to their installation conditions (e.g. in line with the air exhaust ductwork), no direct touch guard is required if the installation conditions provide an equivalent level of safety. Note that the air exhaust fan user is liable for compliance with current safety standards and may be held liable for accidental injury or death caused by failure to provide the required safety equipment.

### Electrical connections

- Electrical connections and commissioning of the fan shall only be completed by qualified professional electricians.
- Always follow the applicable standards, safety regulations and technical requirements specified by the power company!

- The power supply line for the fan requires a multi-pole circuit breaker / isolation switch with a minimum contact break gap of 3 mm (ref. PN-EN 60335-1)!
- The mains system, voltage and frequency must match the nameplate ratings of the fan.
- Fans with the stop delay timer: the maximum voltage limit on terminal T to initiate the stop delay time countdown or start the air exhaust fan is approx. 130 V AC.

## Dimensions

The dimensions of specific fan models are shown in Fig. 5.

## MAINTENANCE AND CLEANING

### Servicing and maintenance

- Use protective footwear and gloves during maintenance!
- During all maintenance and servicing works the electrical and OHS regulations (PN-IEC 60364-3) must be observed.
- Before servicing the fan, isolate it from the mains voltage with the circuit breaker. Secure the circuit breaker against inadvertent operation!
- The fan ductwork must be clear of foreign bodies: hazard of injury by objects blown out at a high speed!
- Do not attempt any maintenance when the fan is running or at live voltage!
- If excessive vibrations are felt or heard, have the technical inspection carried out by a qualified electrician.
- The maintenance intervals depend on the actual contamination of the fan rotor and must not be longer than 6 months!
- Check the fan rotor for cracks.
- The manufacturer shall not be liable for any damage resulting from unprofessional repairs.
- For equipment where engines with ball bearings have been used with "lifetime lubrication", the engine does not require lubrication.

### Cleaning



**Electrocution hazard by damaged wiring insulation!**

**Before attempting to clean the fan, isolate it from the mains voltage with the circuit breaker.**

**Secure the circuit breaker against inadvertent operation!**

- Clean the front panel and the visible parts of the housing with a damp cloth.



- Do not use aggressive paint solvents!
- Do not clean with a high pressure cleaner or strong jets of water!
- Clean carefully to prevent water from entering the motor or the terminal box.
- Always keep the guard grille at the suction side clean.

## WARRANTY TERMS & CONDITIONS

1. warranty period for the proper operation of the fan 5 years, from the date of sale.
2. The warranty rights and obligations will be void and null without demonstrating a proof of purchase (a receipt or an invoice).
3. The warranty covers all defects and damage attributable to the manufacturer.
4. Have your product delivered for warranty servicing to the manufacturer or the original seller.
5. The manufacturer undertakes to repair the product or replace it with a new counterpart within 14 days from filing your warranty complaint.
6. The warranty does not cover any of the following: damage to the product attributable to improper or unqualified installation, operation against the intended use, improper transport, storage and/or maintenance, any faults attributable to unauthorized repairs, or any accidental damage.
7. The warranty does not cover the installation or the maintenance of the product.
8. For all matters not provided for by this Warranty Certificate, the Polish Civil Code (Articles 577- 582) shall apply.

## Do not dispose of waste electrical equipment with household waste.

The crossed-out wheelie bin symbol on this product means that it is waste of electrical and electronic equipment (WEEE) at the end of its operating life and shall not be disposed with household waste. The crossed-out wheelie bin symbol specifies that the product is subject to obligatory waste segregation schedules for proper disposal.



The product is made from recyclable materials and components. The product user is required to return the product which has become WEEE to a WEEE collection unit. The operators of WEEE collection units, including local WEEE locations, product resellers and other WEEE collection locations managed by local authorities form a proper waste disposal system. Proper WEEE disposal helps avoid harmful effects to humans and the environment from the risk caused by hazardous components this product may contain. The household plays an important role in contributing to reuse and recovery, including recycling, of used up appliances, and it is the stage where attitudes are created that impact the preservation of the common being the clean natural environment. Households are among the leading consumers of small appliances and equipment. A rational management of operation and disposal of small appliances and equipment will contribute to efficient recycling.

Rys. 1  
Fig. 1  
Изобр. 1  
Obr. 1

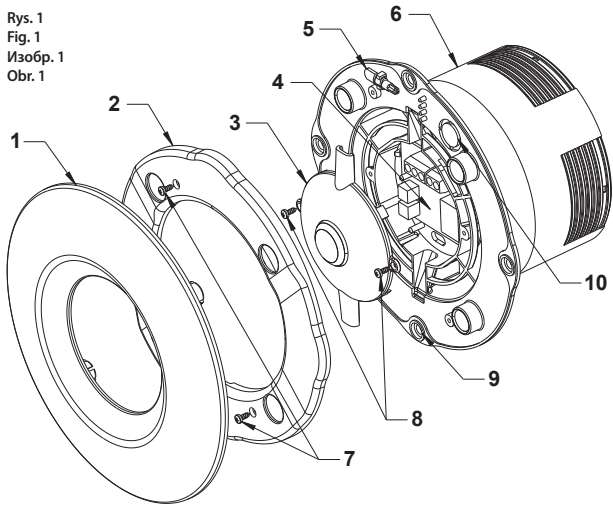

Rys. 2  
Fig. 2  
Изобр. 2  
Obr. 2

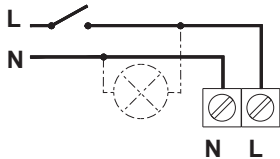

Rys. 3  
Fig. 3  
Изобр. 3  
Obr. 3

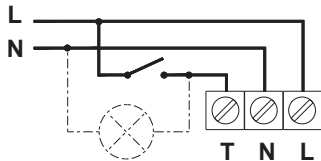

Rys. 4  
Fig. 4  
Изобр. 4  
Obr. 4

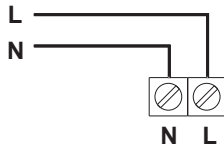

Rys. 5  
Fig. 5  
Изобр. 5  
Obr. 5

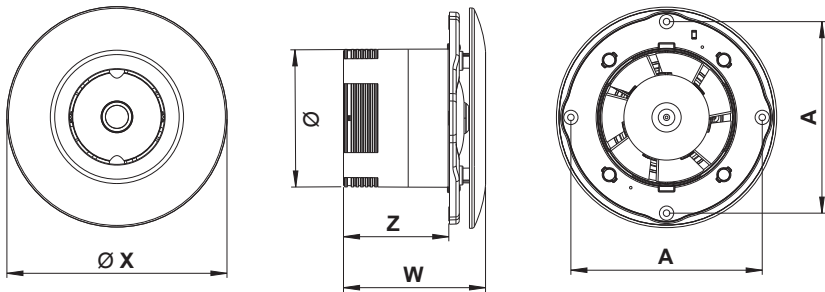

INDEX / ИНДЕКС	Ø	ØX	Z	W	A
WXO100	100	160	77	103	139
WXO125	125	187	77	107	164
WXO150	150	210	83	120	189
WXS100	100	160	77	107	139
WXS125	125	187	77	112	164
WXS150	150	210	83	125	189
WXA100	100	160	77	110	139

Rys. 6  
Fig. 6  
Изобр. 6  
Obr. 6

SOCZEWKA CZUJKI/SENSOR LENS/  
ОБЪЕКТИВ ДЕТЕКТОРА/ČOČKA DETEKTORU/  
ŠOŠOVKA SNÍMAČA

WIDOK Z GÓRY/TOP VIEW/ВИД СВЕРХУ/  
POHLED SHORA/POHLAD ZHORA

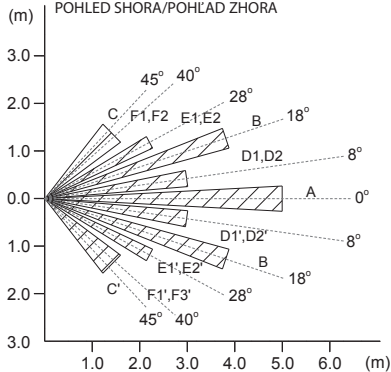

WIDOK Z BOKU/  
SIDE VIEW/ВИД СБОКУ/  
BOČNÍ POHLED/  
POHLED ZBOKU

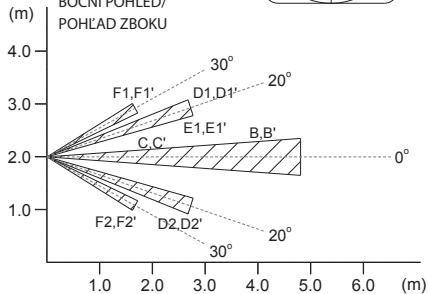

PION/VERTICAL ORIENTATION/ВЕРТИКАЛЬ/  
VERTIKÁLNÍ POLOHA/ZVISLO

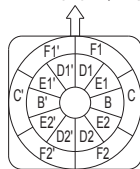

POZIOM/  
HORIZONTAL  
ORIENTATION/  
ГОРИЗОНТАЛЬ/  
ÚROVEŇ/ÚROVEŇÍ

**Awenta**  
SINCE 1989

*Producent / Manufacturer / Производитель / Výrobce / Výrobca:*

**AWENTA Spółka Jawna**

*05-300 Mińsk Mazowiecki, Stojadła, ul. Warszawska 99, Poland*

*Tel: +48 25 758 52 52, + 48 25 758 93 92 fax: +48 25 758 14 62*

*e-mail: [info@awenta.pl](mailto:info@awenta.pl) [www.awenta.pl](http://www.awenta.pl)*